

SANWA STAINLESS STEEL

# MAGNET DRIVE PUMP

## MAGPAC<sup>®</sup> series

MMP / MP



SANWA PUMP

Compact Design with Easy Maintenance

Highly Durable and Reliable

Wide Range of Application

*Stainless  
Steel*



MANUFACTURER

SANWA HYDROTECH CORPORATION

[www.sanwapump.com](http://www.sanwapump.com)



As we enter the 21st Century, environmental concerns, new technology, and renovated manufacturing techniques make changes in pumping equipment mandatory...yet, very feasible. Stainless steel, sealless magnet drive pumps with leak free construction, safety, reliability and long life can now fulfill the requirements and demands of today's pumping requirements.

Completely leak-free Magnet Drive Pumps **MAGPAC® series**

**SANWA STAINLESS STEEL  
MAGNET DRIVE PUMP**

**TYPE MMP** Motor output : **0.37kW to 0.55kW**  
Small Magnet Drive Pump For Equipment Use

**TYPE MP**  
Motor output : **0.75kW to 7.5kW**

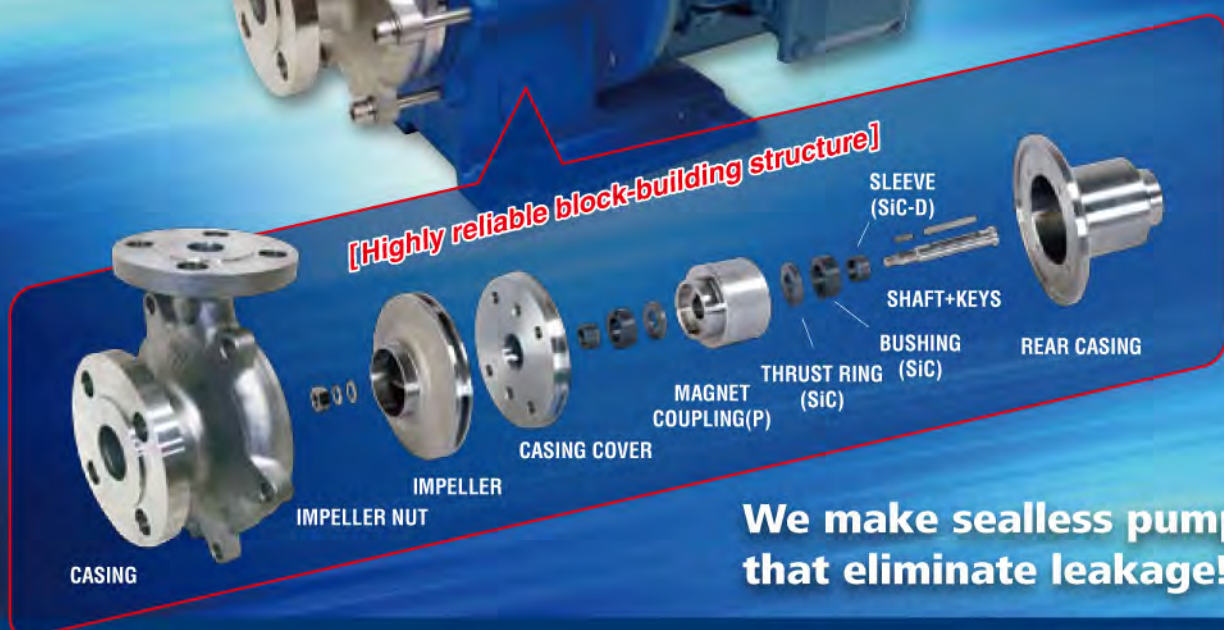

**We make sealless pumps that eliminate leakage!**

**Significantly increased dry running capability!**

- SiC-D bearings can withstand accidental dry run for extended periods.
- Unique materials and manufacturing techniques of our specially treated SiC-D bearings provide a coefficient of friction 1/4 that of SiC.
- The very low coefficient of friction of our SiC-D bearings results in much less heat being generated in upset or dry running conditions. SiC-D bearings are more forgiving of dry running conditions frequently encountered at start up, during upset conditions or in batch services. Extremely hard surfaces minimize wear and prolong service life; resistance to chemicals is maintained for extended bearing life.





## Construction and Materials

### TYPE MMP

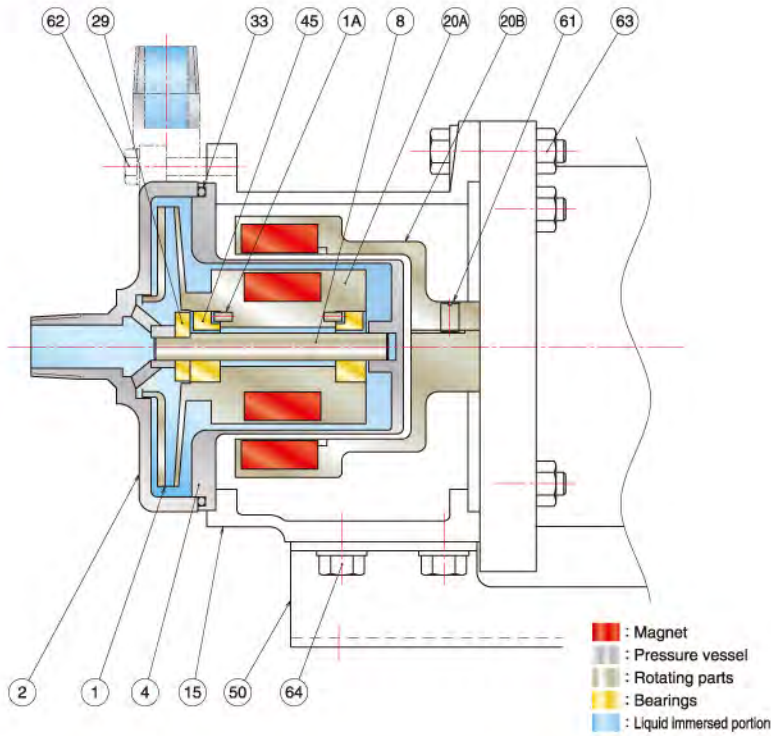

MMP11  
(Standard)

64	BOLT WITH WASHER	SS	4 <sup>S</sup>
63	BOLT WITH WASHER	SS	4 <sup>S</sup>
62	BOLT WITH WASHER	SS	6 <sup>S</sup>
61	SET SCREW	SS	1
50	BASE	SS	1
45	BUSHING	SiC-D	2
33	O RING	PTFE	1
29	THRUST RING	SIC	1
20B	MAGNET	RE	1 <sup>S</sup>
	MAGNET COUPLING(M)	FCD	1
20A	MAGNET	RE	1 <sup>S</sup>
	MAGNET COUPLING(P)	SS	1
15	FRAME ADAPTER	FC200	1
8	SHAFT	SiC	1
4	REAR CASING	SS	1
2	CASING	SS	1
1A	PIN	SS	2
1	IMPELLER	SS	1
MARK	NAME OF PART	MAT'L	No.REQ'D

※ SS = Stainless Steel, RE = Rare Earth

## Simple & Tough

### TYPE MP

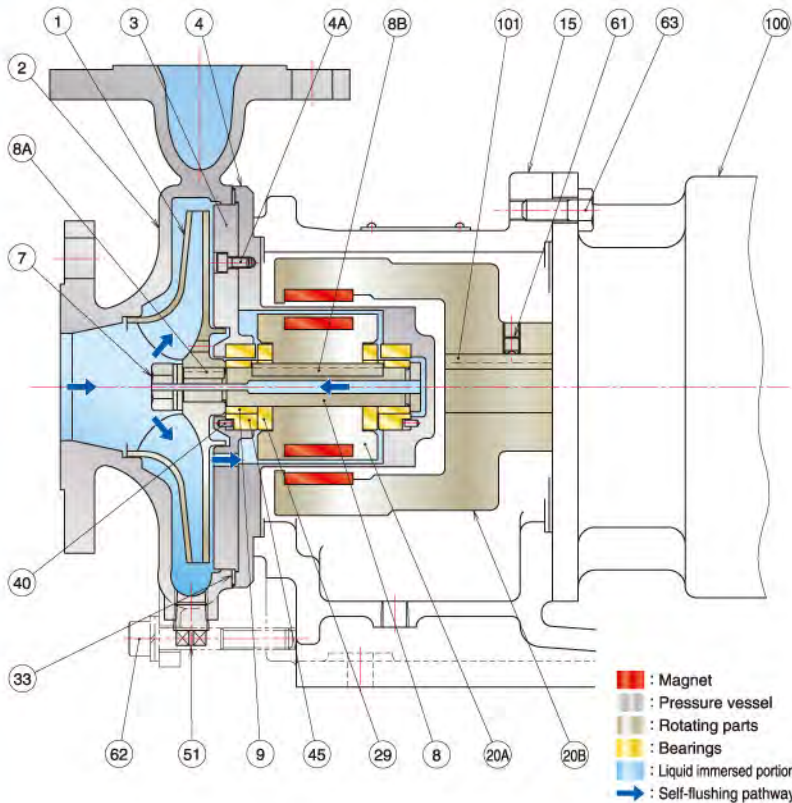

MP220  
(Standard)

101	COUPLING KEY(M)	Fe	1
100	MOTOR	-	1
63	HEXAGON HEAD BOLT	SS	4 <sup>S</sup>
62	HEXAGON SOCKET HEAD CAP SCREW WITH WASHER	SS	6 <sup>S</sup>
61	SET SCREW	Fe	1
51	PLUG	SS	1
45	BUSHING	SiC	2
40	PIN	SS	2
33	SHEET GASKET	PTFE	1
29	THRUST RING	SIC	2
20B	MAGNET	RE	1 <sup>S</sup>
	MAGNET COUPLING(M)	Fe	1
20A	MAGNET	RE	1 <sup>S</sup>
	MAGNET COUPLING(P)	SS	1
15	FRAME ADAPTER	Fe	1
9	SLEEVE	SiC-D	2
8B	COUPLING KEY(P)	SS	1
8A	IMPELLER KEY	SS	1
8	SHAFT	SS	1
7	IMPELLER NUT WITH WASHER	SS	1 <sup>S</sup>
4A	HEXAGON SOCKET HEAD CAP SCREW	SS	4
4	REAR CASING	SS	1
3	CASING COVER	SS	1
2	CASING	SS	1
1	IMPELLER	SS	1
MARK	NAME OF PART	MAT'L	No.REQ'D

※ SS = Stainless Steel, RE = Rare Earth

## Specifications

		TYPE MMP	TYPE MP
Design pressure		0.6MPaG	1.0MPaG
Max. Temperature		150°C	
Min. Temperature		-30°C	
Type of impeller		Closed	
Material	PUMP	Stainless Steel 316 etc.	
	O Ring or Sheet Gasket	PTFE	
	Bearing	SiC-D	
Motor		3Phase 200V / 220V / 380V / 400V / 440V	

## Typical Performance

Frequency (Hz)	Pump Type & Size	Bore		MOTOR (kW)	Typical Performance			S.G.	VIS. (mPa.s)
		Suction	Discharge		Total Head(m)	Capacity (ℓ/min.)	NPSH req.(m)		
60	MMP11	15mm (Rc 1/2)	15mm (Rc 1/2)	0.37	15	24	3.3	~ 1.0	Less than 10
	MMP21	20mm (Rc 3/4)	20mm (Rc 3/4)	0.55	24	30	1.4		
	MMP22	25mm (Rc 1)	20mm (Rc 3/4)	0.55	12	60	2.1		
	MP210	25A	20A	0.75	13	90	1.2		
	MP220	25A	20A	1.5	21	90	2.7		
	MP221	25A	20A	2.2	35	100	2.3		
	MP222	25A	20A	4.0	52	120	2.4		
	MP420	40A	25A	2.2	23	200	1.5		
	MP421	40A	25A	4.0	30	260	2.0		
	MP541	50A	40A	4.0	25	340	1.6		
	MP542	50A	40A	4.0	40	200	1.2		
	MP423	40A	25A	7.5	65	150	2.1		
	MP543	50A	40A	7.5	42	450	2.0		
	MP842	80A	40A	7.5	30	700	3.0		
50	MMP11	15mm (Rc 1/2)	15mm (Rc 1/2)	0.37	10	20	2.5	~ 1.0	Less than 10
	MMP21	20mm (Rc 3/4)	20mm (Rc 3/4)	0.55	15	40	2.1		
	MMP22	25mm (Rc 1)	20mm (Rc 3/4)	0.37	8	50	1.8		
	MP210	25A	20A	0.75	9	80	1.2		
	MP220	25A	20A	0.75	15	70	2.0		
	MP221	25A	20A	1.5	25	85	2.1		
	MP222	25A	20A	2.2	36	100	2.0		
	MP420	40A	25A	1.5	16	180	1.4		
	MP421	40A	25A	2.2	20	200	1.8		
	MP541	50A	40A	2.2	18	300	1.6		
	MP542	50A	40A	4.0	30	260	1.2		
	MP423	40A	25A	5.5	50	100	1.3		
	MP543	50A	40A	5.5	33	400	1.6		
	MP842	80A	40A	5.5	26	600	2.1		

**Please contact the agency if you have any question about the specifications of the pump.**



< The relation of S.G. and viscosity to pump performance >

Performance curves assume liquid pumped is water with S.G. of 1.0 and viscosity of 1.0mPa.s.

Pump performance will be affected with liquids which have a S.G. and viscosity different than water.

• Specific Gravity ( : S.G.)

Capacity (ℓ/min.) : **No change**

Total head (m) : **No change**

Power (kW) : **Increase or decrease**

• Viscosity (10 cSt and above)

Capacity (ℓ/min.) : **Decrease**

Total head (m) : **Decrease**

Power (kW) : **Increase**



**Selection Chart**

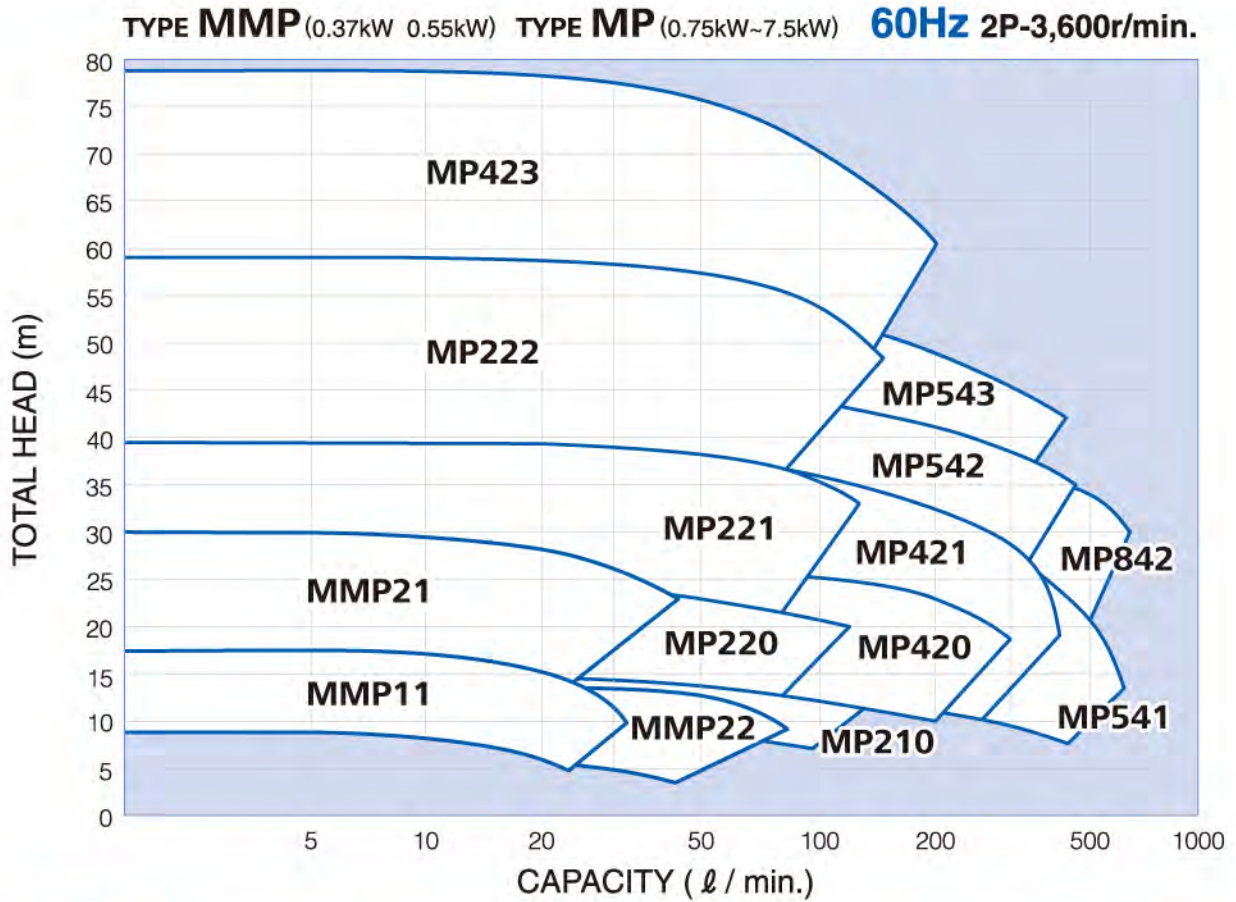

**Low NPSH & High Efficiency**

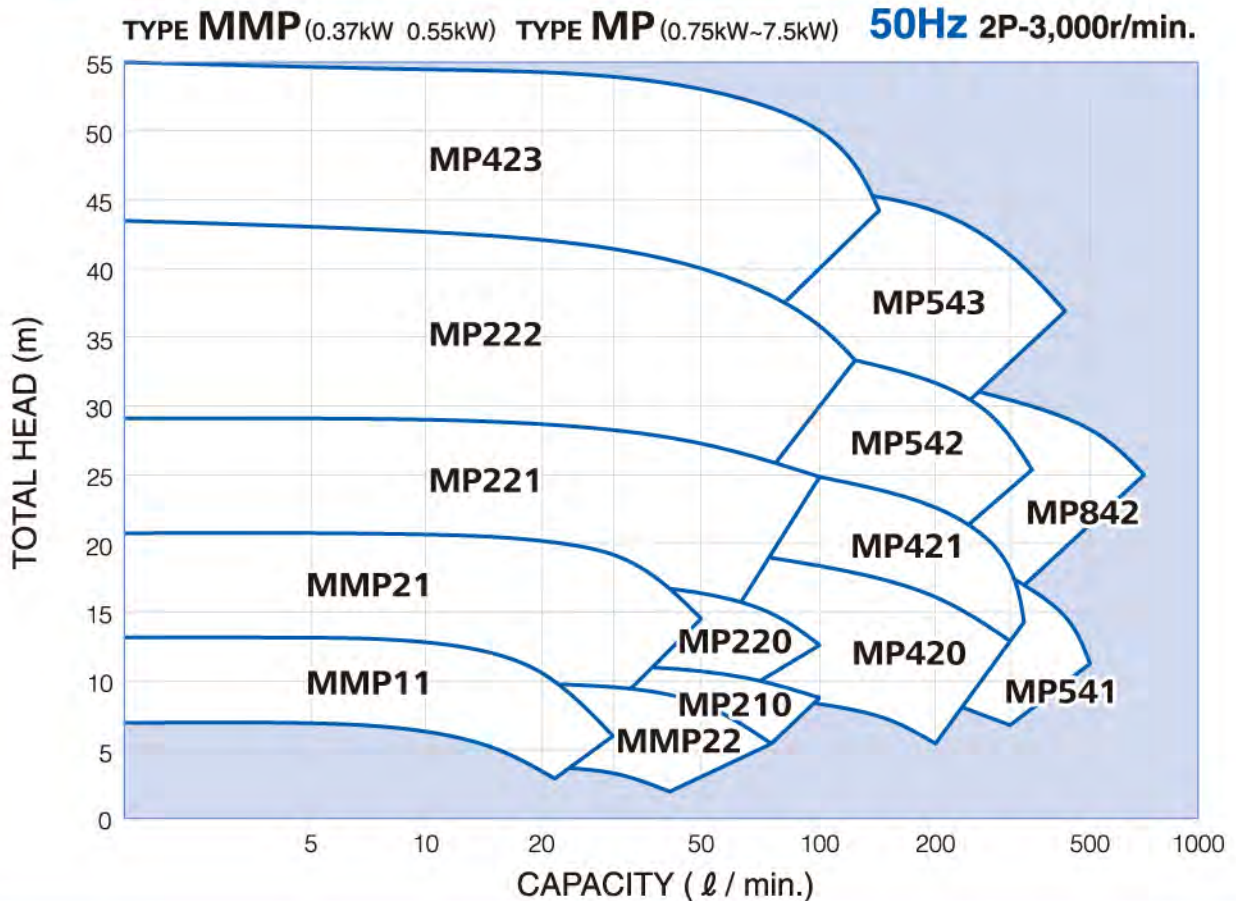

## Outline Dimension

### TYPE MMP

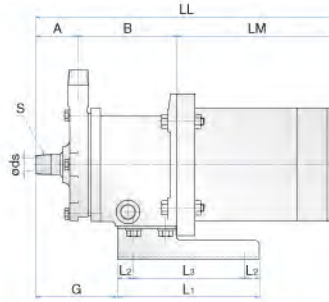
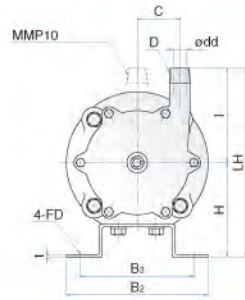

( In the unit of mm )

PUMP SIZE	MOTOR		BORE				PUMP & MOTOR							BASE PLATE							WEIGHT APPROX(kg)				
	FRAME SIZE	OUTPUT (W)	SUCT		DISCH		A	B	C	H	I	LH	LM	LL	G	L <sub>1</sub>	L <sub>2</sub>	L <sub>3</sub>	B <sub>2</sub>	B <sub>3</sub>	t	FD	PUMP	MOTOR	TOTAL
			ds	S	dd	D																			
MMP11	71M	370	15	R1/2	15	R1/2	45	111	45	100	100	200	225	381	86	150	16	118	150	120	3	ø9.5	8.0	11.0	19.0
MMP21	71M	550	20	R3/4	20	R3/4	50	112	50	100	120	220	225	387	77	150	16	118	150	120	3	ø9.5	11.0	11.0	22.0
MMP22	71M	370/550	25	R1	20	R3/4	60	113	45	100	100	200	225	398	103	150	16	118	150	120	3	ø9.5	10.0	11.0	21.0

※ LM,LL dimensions and motor weight may vary depending on motor used.

### TYPE MP

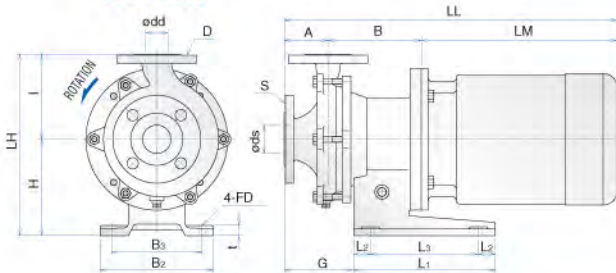

(MP423, MP543, MP842)

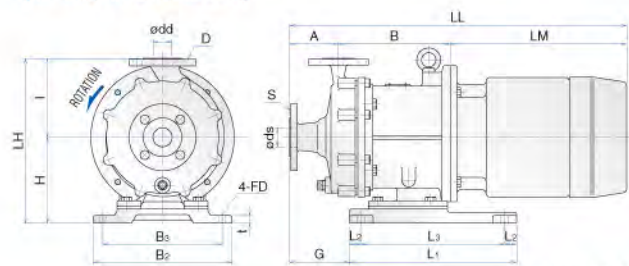

( In the unit of mm )

PUMP SIZE	MOTOR		BORE				PUMP & MOTOR							BASE PLATE							WEIGHT APPROX(kg)			
	FRAME SIZE	OUTPUT (kW)	SUCT		DISCH		A	B	H	I	LH	LM	LL	G	L <sub>1</sub>	L <sub>2</sub>	L <sub>3</sub>	B <sub>2</sub>	B <sub>3</sub>	t	FD	PUMP	MOTOR	TOTAL
			ds	S	dd	D																		
MP210	80M	0.75	25		20		75	170	110	105	215	245	490	125	180	30	120	160	130	12	ø12	22	12.5	34.5
MP220	80M	0.75	25		20		60	170	110	120	230	245	475	110	180	30	120	160	130	12	ø12	23	12.5	35.5
	90L	1.5										260	490									23	16.5	39.5
MP221	90S/90L	1.5, 2.2	25		20		65	165	170	130	300	260	490	110	250	30	190	200	160	18	ø12	27	18	45
													285											
MP222	90L	2.2	25		20		65	165	170	140	310	285	515	110	250	30	190	200	160	18	ø12	29	18	47
	112M	4.0						175				335	575									33	37	70
MP420	90S/90L	1.5, 2.2	40		25		75	170	170	135	305	260	505	125	250	30	190	200	160	18	ø12	29	18	47
													285											
MP421	90L	2.2	40		25		75	170	170	135	305	285	530	125	250	30	190	200	160	18	ø12	30	18	48
	112M	4.0						180				335	590									34	37	71
MP541	90L	2.2	50		40		80	170	170	140	310	285	535	130	250	30	190	200	160	18	ø12	31	18	49
	112M	4.0						180				335	595									35	37	72
MP542	112M	4.0	50		40		65	175	170	150	320	335	575	110	250	30	190	200	160	18	ø12	38	37	75
MP423	132S	5.5, 7.5	40		25		102	234	180	165	345	385	721	125	350	25	300	290	250	18	ø15	63	61	124
MP543	132S	5.5, 7.5	50		40		102	234	180	165	345	385	721	125	350	25	300	290	250	18	ø15	65	61	126
MP842	132S	5.5, 7.5	80		40		102	234	180	165	345	385	721	125	350	25	300	290	250	18	ø15	67	61	128

※ LM,LL dimensions and motor weight may vary depending on motor used.



Other Models in MAGPAC Series



TYPE MMH

*For liquid of high temperature*  
R.T.~+280°C



TYPE MH

*For liquid of high temperature*  
R.T.~+280°C

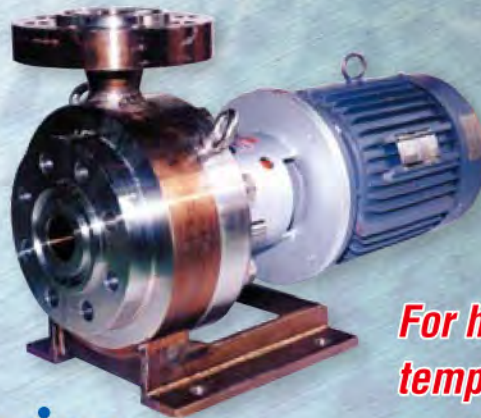

*For high pressure and high temperature application*  
100barG / max. +300°C

**MAGPAC® series**

STAINLESS MAG Series



Stainless Magnet Drive Pump  
**STAINLESS MAG**



M1503-W5  
(Standard)



M2505-W5  
(Standard)



M4022-W5-FJ  
(Option)  
O RING : Fluorine Rubber  
CONNECTION : PIPE With FLANGE  
ISO 7005 1(JIS 10K RF)

For application out of the above range, please contact us.



*These highly trustworthy pumps provide total support to customers' requirements in various fields with its high quality.*

For about 80 years, with the technological advancement we've mastered, high quality is assured in the field of basic design, material selection as well as test run of final product.

Furthermore, we are constantly working on developing more and more reliable customer relationship from the initial consulting to after service stage.



Kyoto Factory



Made in Japan



MAGPAC SERIES has CE marking.

MANUFACTURER **SANWA HYDROTECH CORPORATION**

**HEAD OFFICE. OVERSEAS BUSINESS DEPARTMENT**

No. 11-33, Minamikaneden 2-chome, Suita, Osaka, 564-0044 Japan

Tel. +81-6-6330-5984 Fax. +81-6-6330-5975

E-mail : [sxobd@sanwapump.co.jp](mailto:sxobd@sanwapump.co.jp)

[English] <http://www.sanwapump.com>

[Japanese] <http://www.sanwapump.co.jp>

- The contents of this catalogue are subject to partial changes without notice, for the reason of product modification.
- The information and data given in this catalogue should not be taken as to guarantee the detail, specification or performance of our products.

